

Part Functionality

E-TBT (Model 9-6080) LED Display

In this section, we will review all the components that make up the E Series E-TBT (Total Body Trainer). To resolve issues that may occur on an E-TBT, it is important to understand all the components and what function they play in the system.

1. Display Assembly (LED)

The display assembly is like the brains of the unit. It controls and commands the TBT to take actions. It is the user interface to control the machine. It also does the following:

- RPM Calculations
- Calorie Calculations
- Pre-designed Programs
- Heart Rate Calculation



There are two main components to the display assembly:

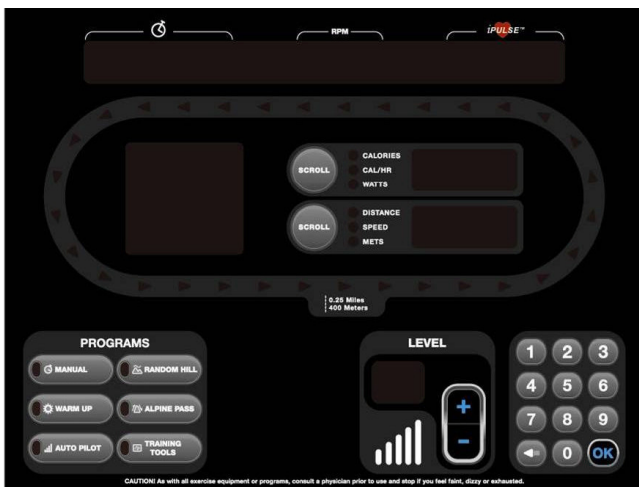

Display Panel

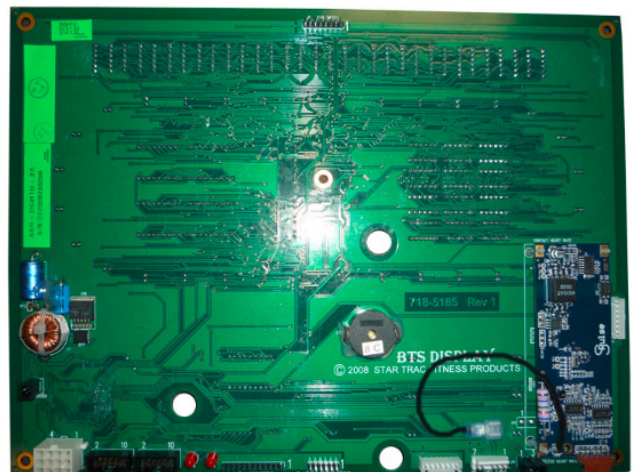

Display Electronics

Components that Connect to the Display Electronic:

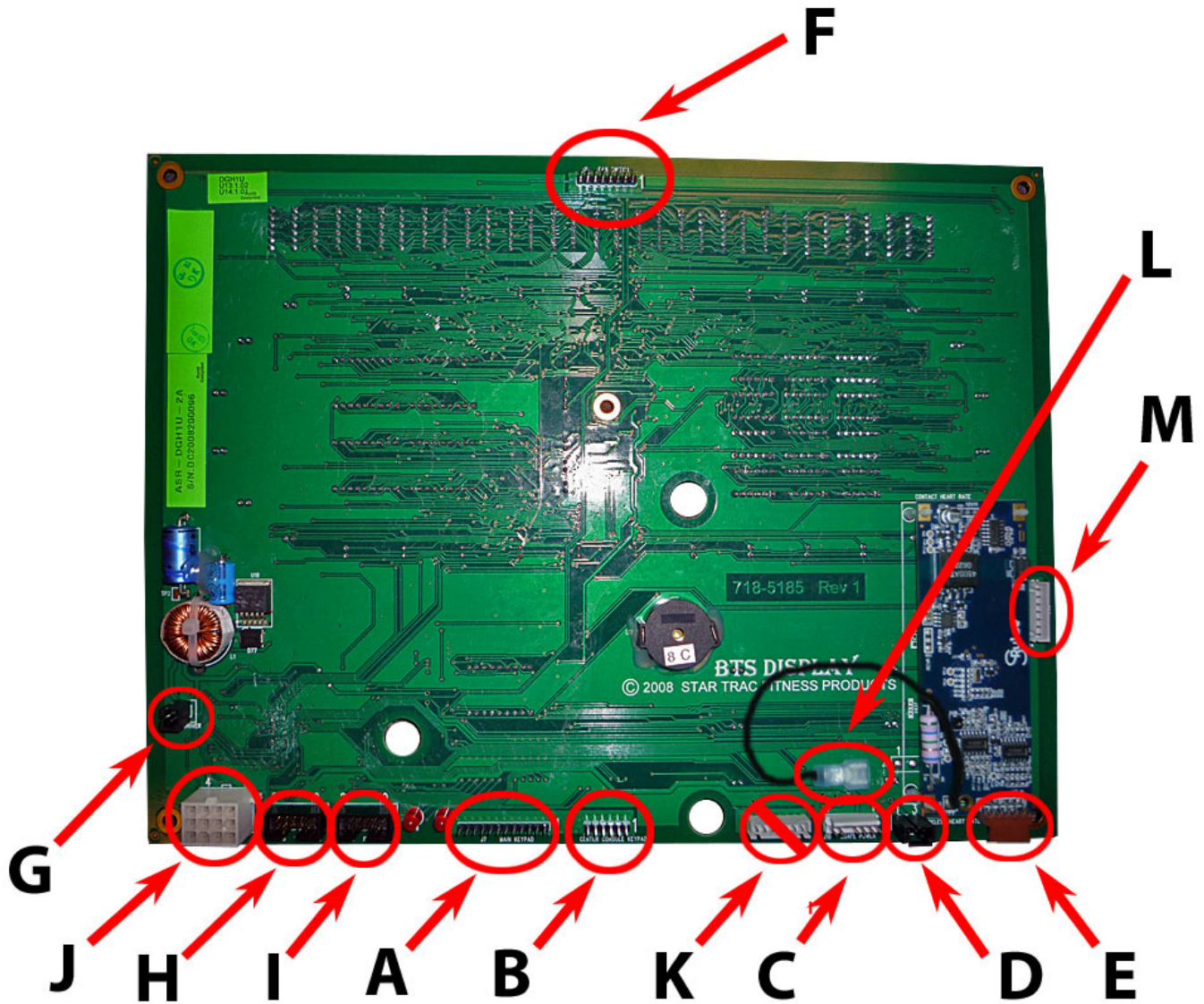

A. Display Panel (J7 – 12 Pin Connector) –The main keypad that is used to enter commands.

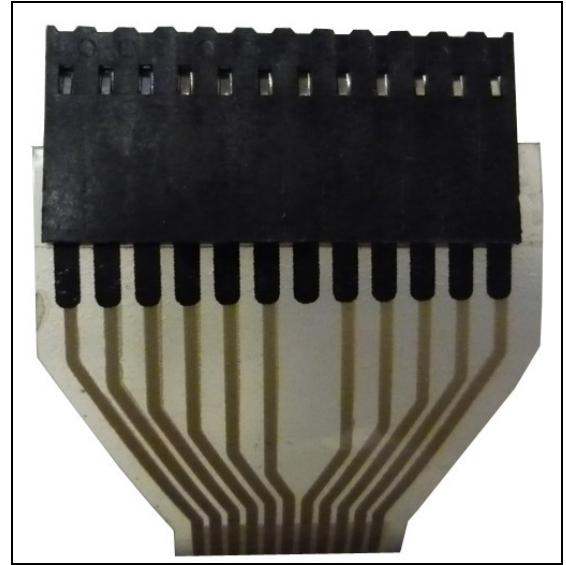

B. Center Console (J8 – 6 Pin Connector) –The small keypad that has the 'Quick Start' key. If the unit has any kind of entertainment, there will be extra keys for that.

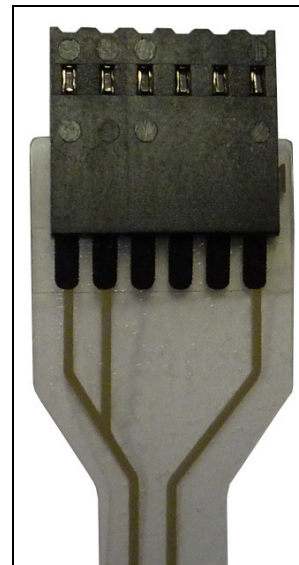
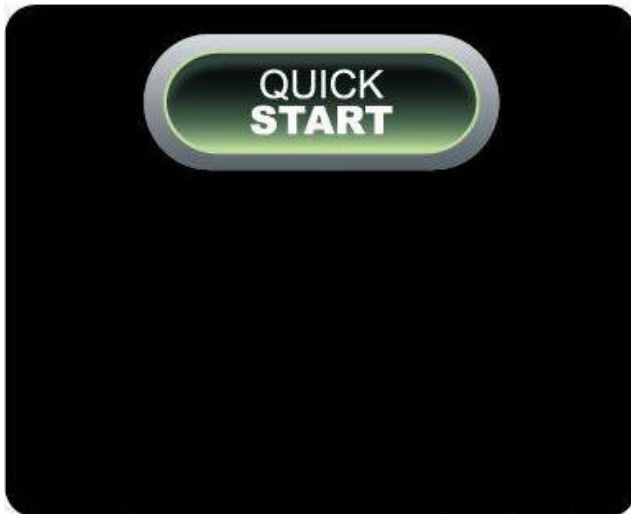

C. CSAFE Power (J10 – 6 Pin Connector) – The external CSAFE port. Note: This port is only used for supplying power to external add on audio accessories.

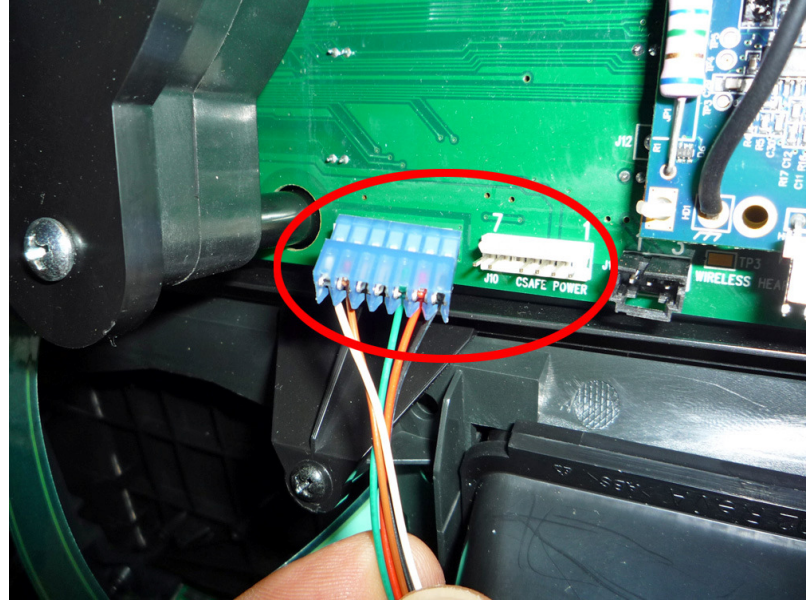
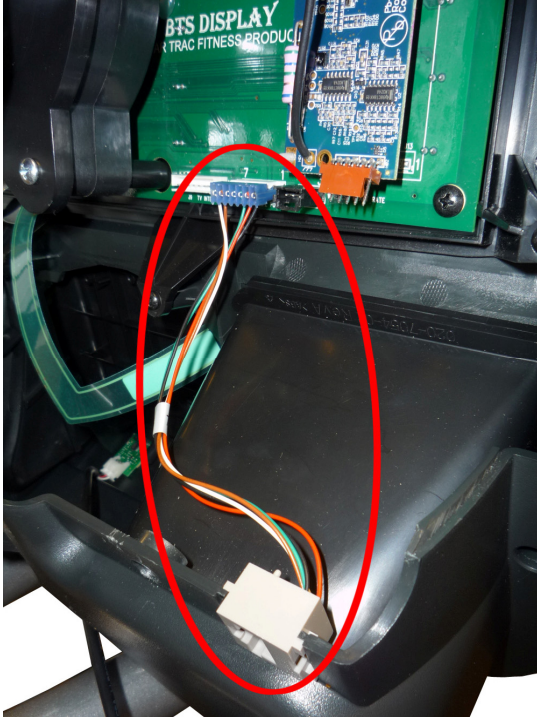

D. Polar Receiver (J11 – 3 Pin Connector) – The telemetry/wireless heart rate (signal sent out by the chest strap).

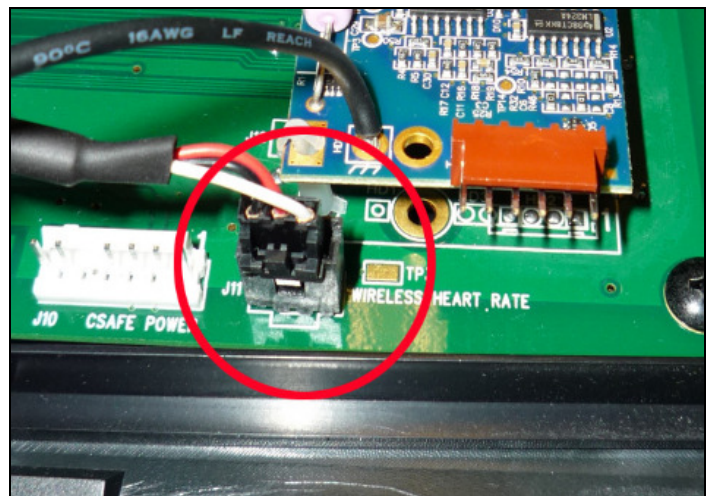
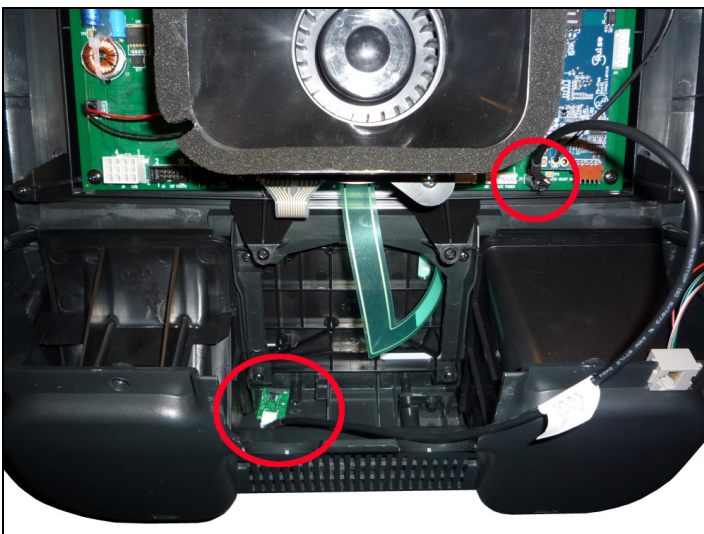

E. Contact Heart Rate (6 Pin Connector on the standoff HR Board) – The contact heart rate board plugs in here. Note: The contact heart rate is typically mounted on the display electronics.

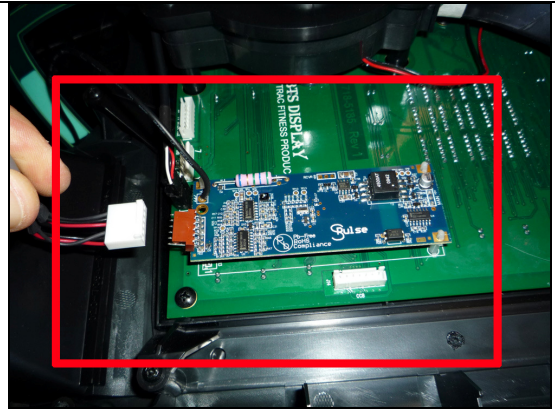
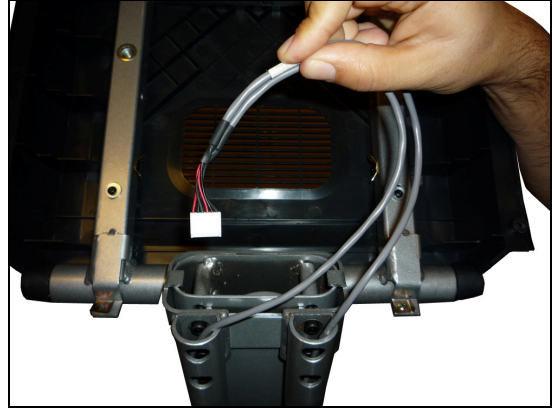
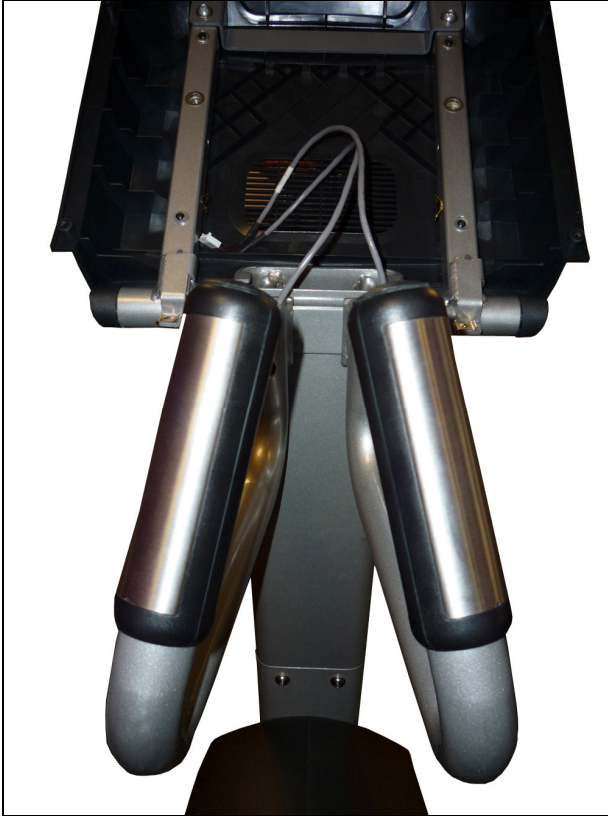

F. Fan Keypad (J1 – 8 Pin Connector) – The small keypad at the top of the display housing.

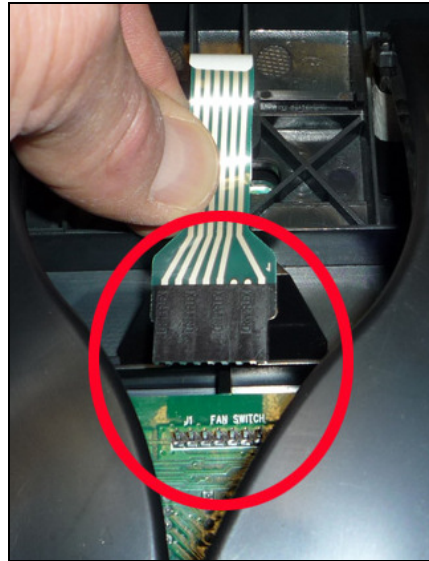

G. Fan Power (J3 – 2 Pin Connector) – The fan gets power from the display electronic.

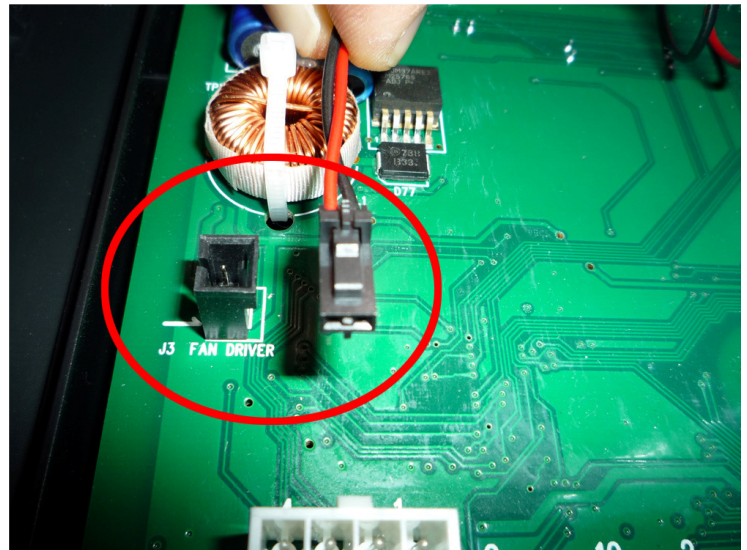
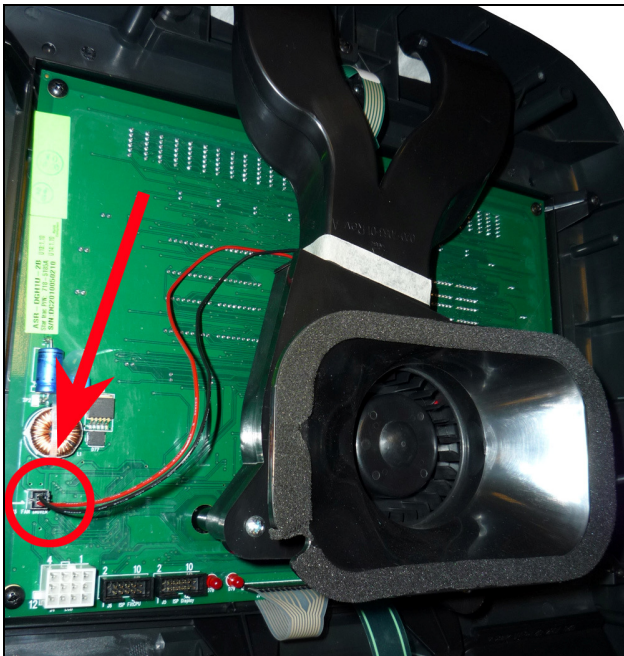

H. Primary Port (J6 – 10 Pin Connector) – The primary port for uploading software into the display.

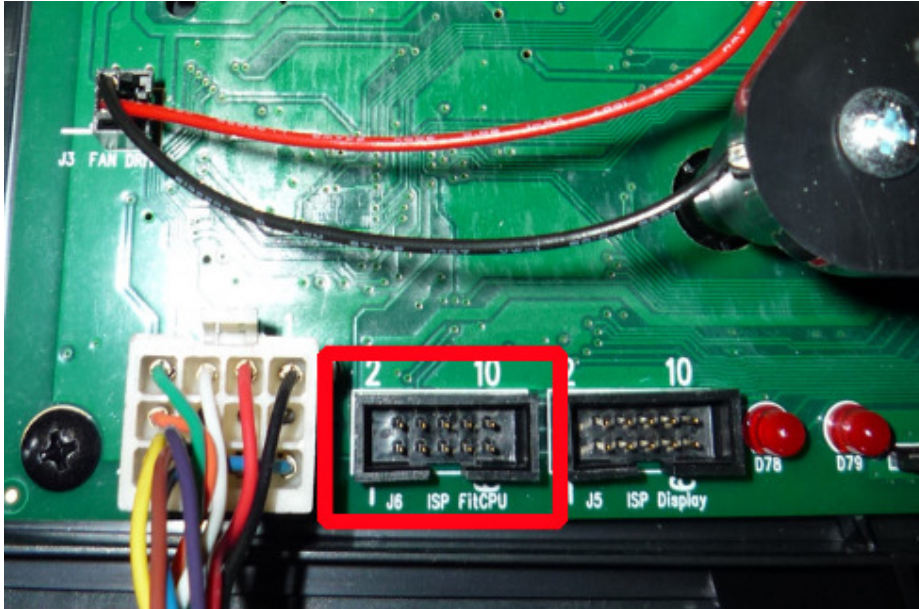

I. Secondary Port (J5 – 10 Pin Connector) – The secondary port for uploading software into the display.

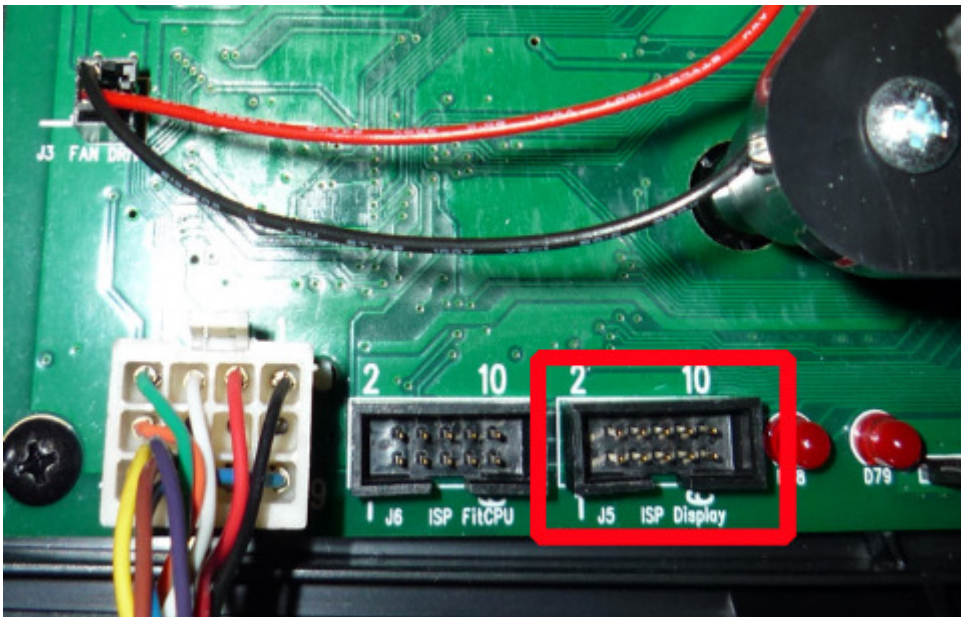

J. Display Cable (J4 – 12 Pin Connector) – This is the main cable that connects the display to the LCB. The display cable is like the nerves of the TBT. Information and power are sent up to the display and back down to the LCB to control the unit. The display cable passes:

- Power to the display
- Commands for resistance level
- Signal for RPM

The Data Cable is polarized so it can not be plugged in incorrectly.

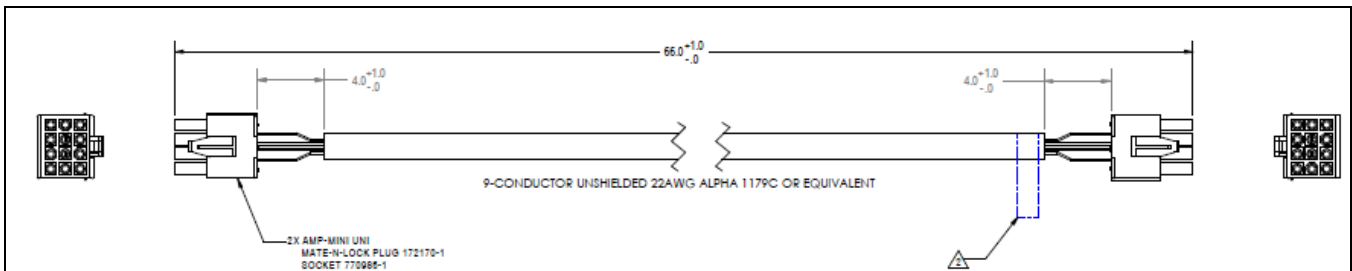
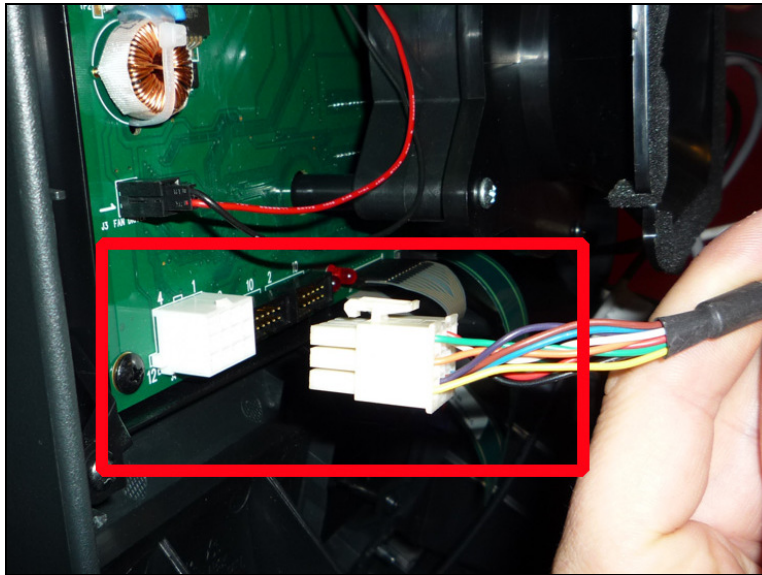

K. TV Interface (J9 – 7 Pin Connector) – NEVER use this port.



L. HR Board Ground Cable (connects to the display frame)



M. CCB (J14 – 7 Pin Connector) Used for PVS and on 'made for iPod' kits only.

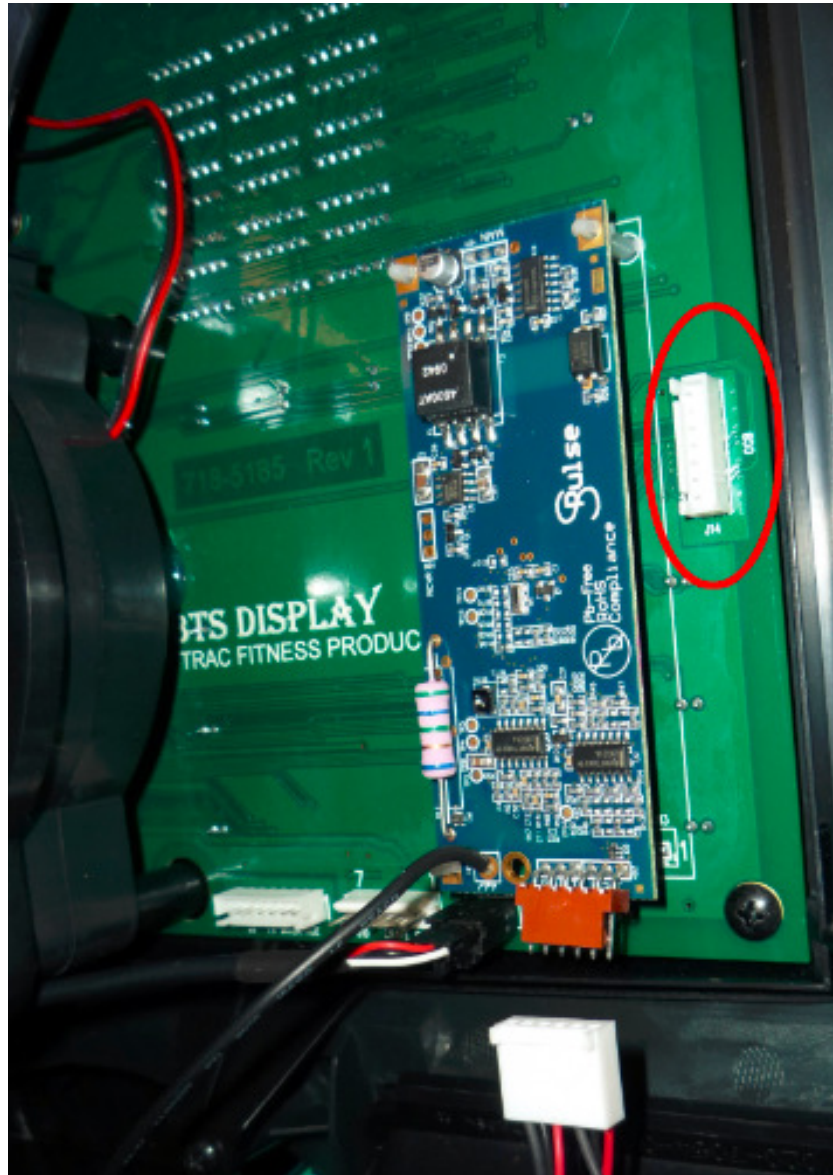

2. Load Control Board (LCB)

Location of the LCB:

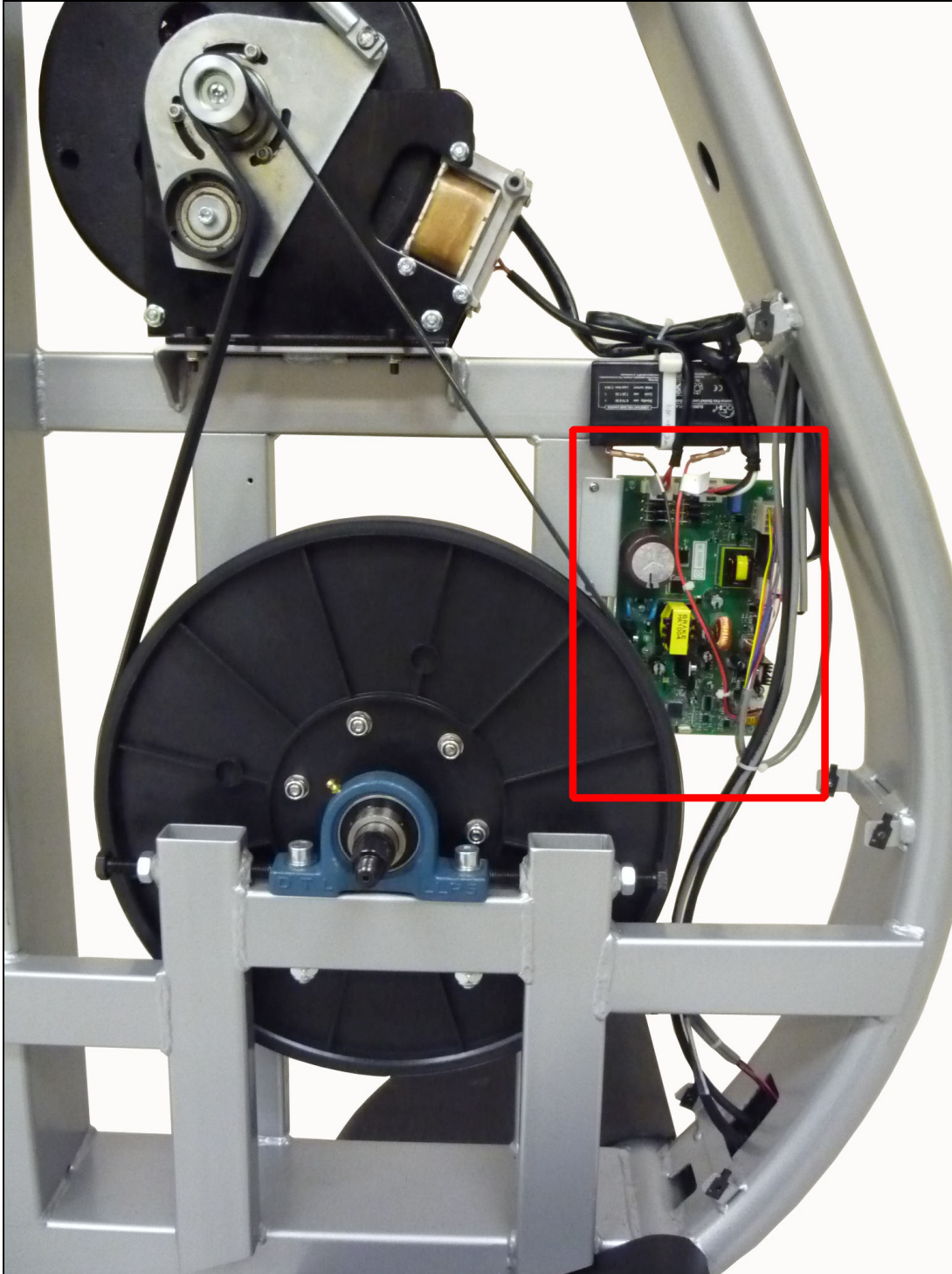

The LCB is the heart of the TBT. The LCB brings the power from brake and conditions it for distribution to the display electronic.

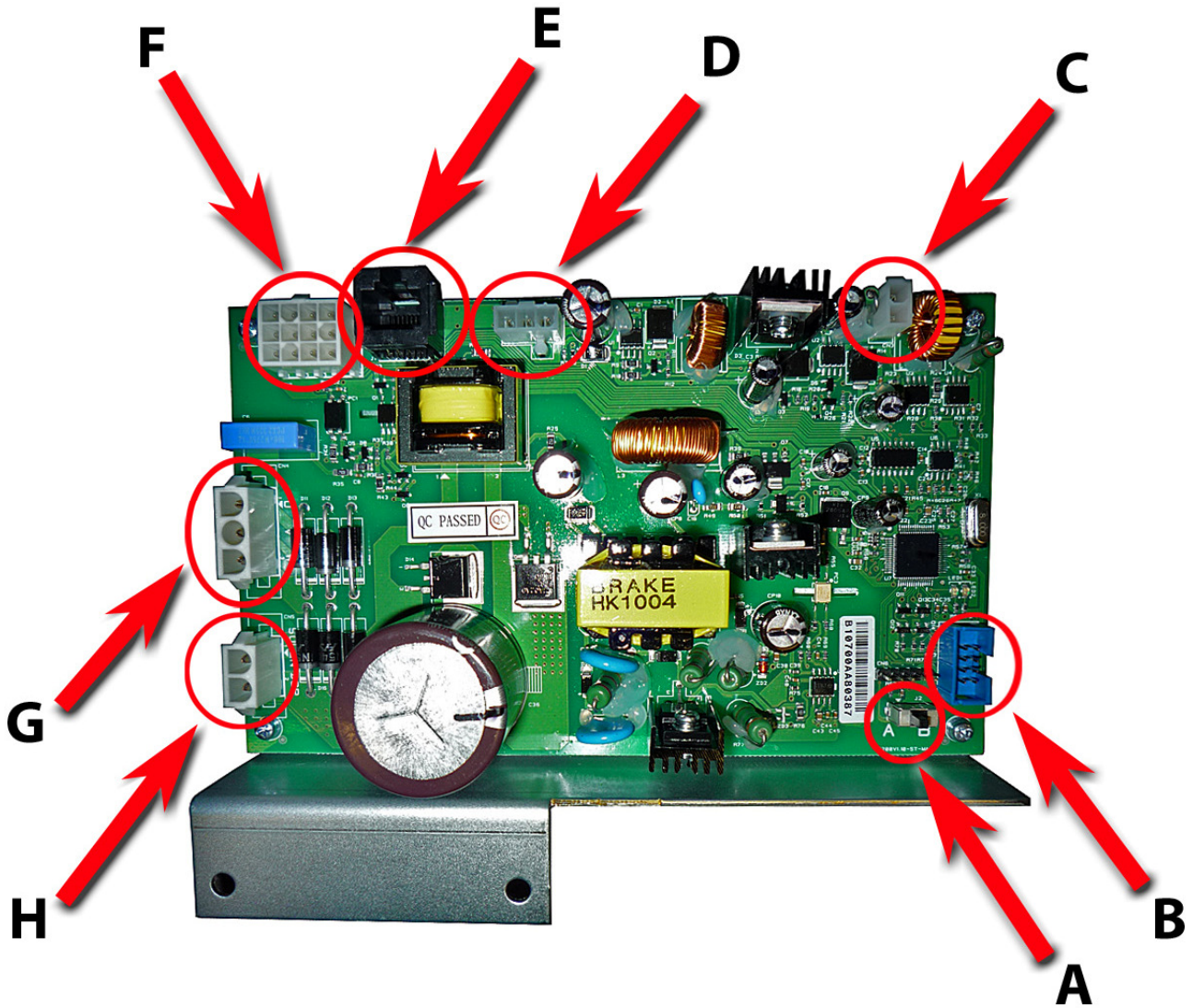

Connections and Components that plug into the ADT LCB (PN: 721-1176)

A. Brake Style Selector Switch (J2) – This switch allows the LCB to work with either brake style see document number 637-1348).

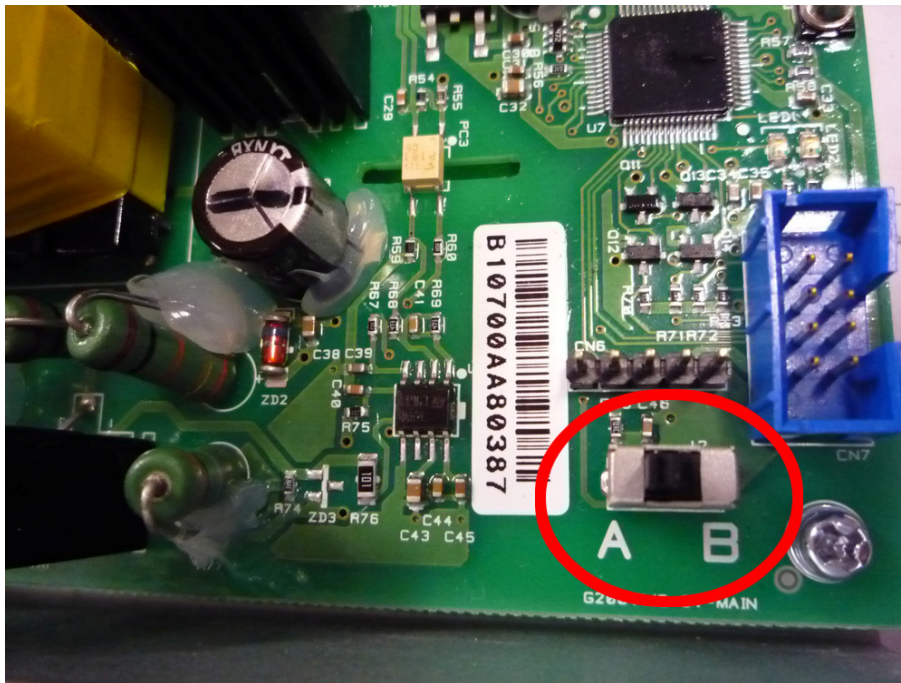

B. CN7 - 8 Pin Connector – This connector is not used on this generation of the E Series TBT. The previous generation with Upper Body Arm movement (Select Fit) need this connector.

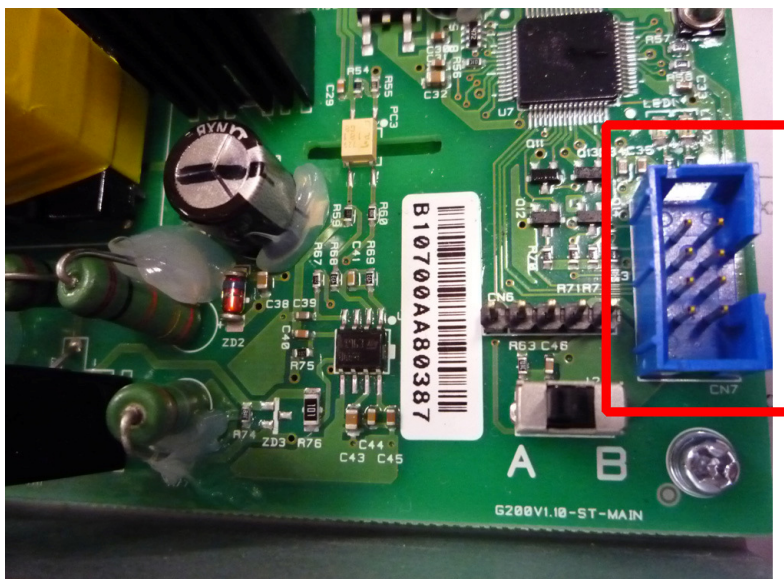

C. Battery Connector (CN3 – 2 Pin Connector) – Delivers power to the display when there is no movement and charges the battery.

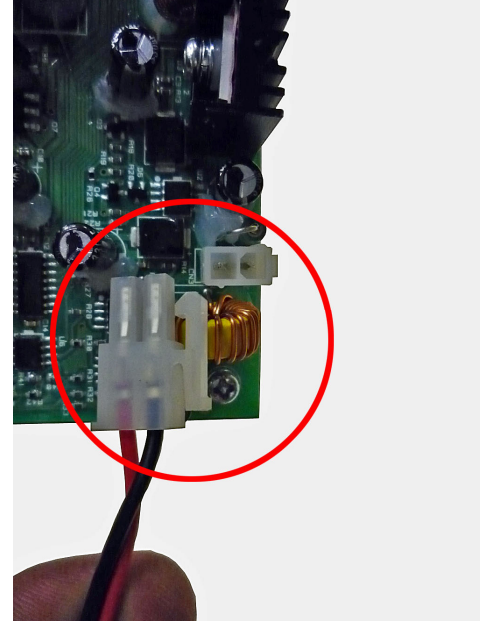
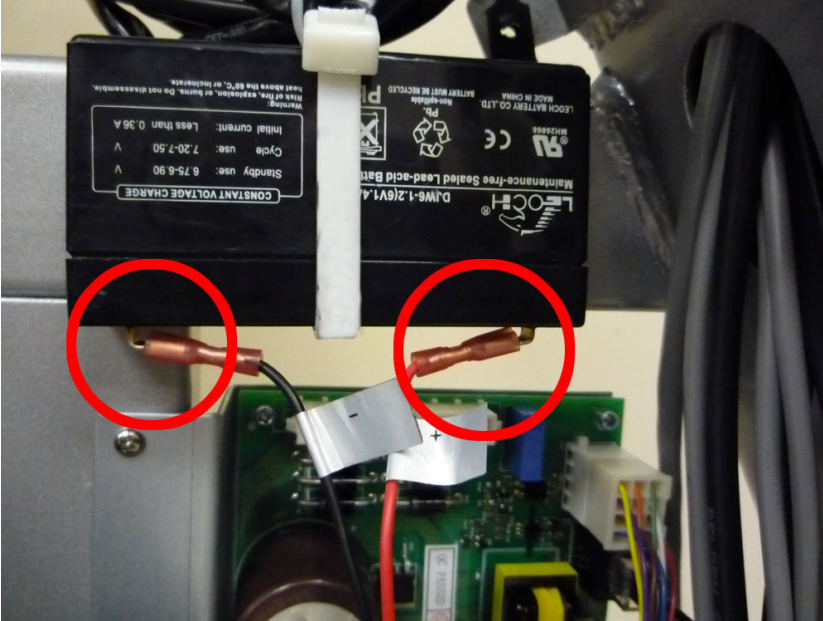

D. External Power Connector (CN2 – 3 Pin Connector) – Supplies 12 Volts to the system.

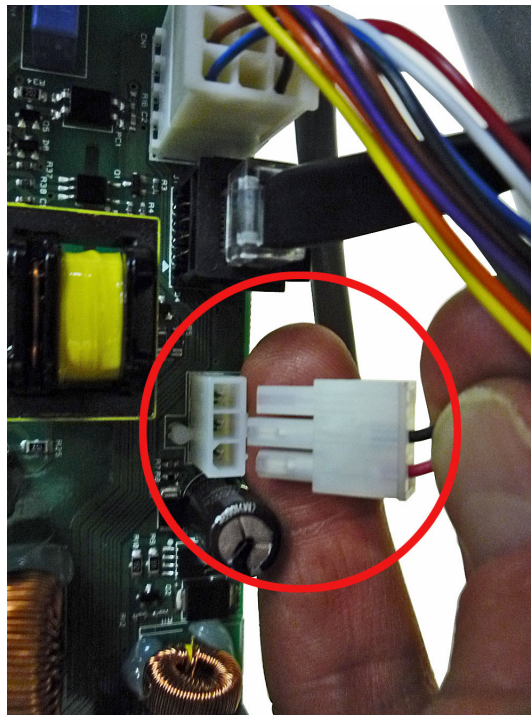

E. C-Save Connector (J1 – 8 Pin) – This is where the external C-Save cable plugs in to the LCB.

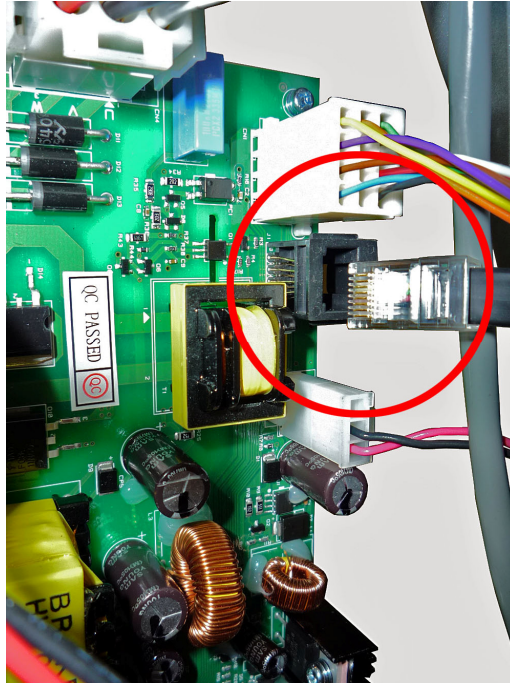

F. Display Cable Connector (CN1 – 12 Pin Connector) – Information and power are sent up to the display and back down to the LCB to control the unit.

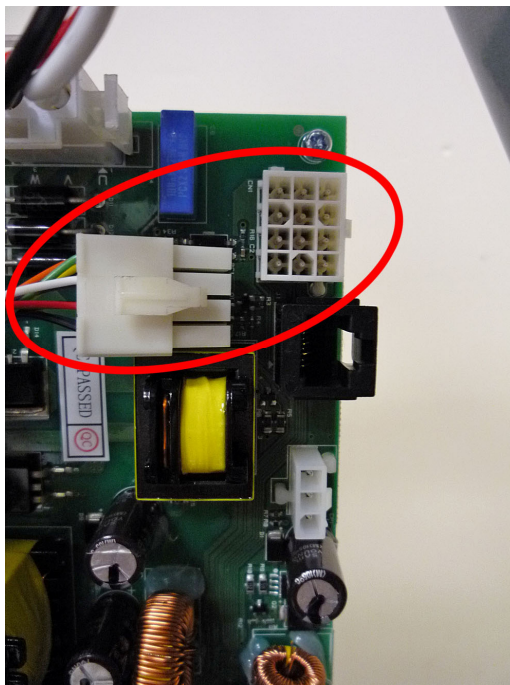

G. Generator Cable Connector (CN4 – 3 Pin Connector) – Brings in the power from the generator.

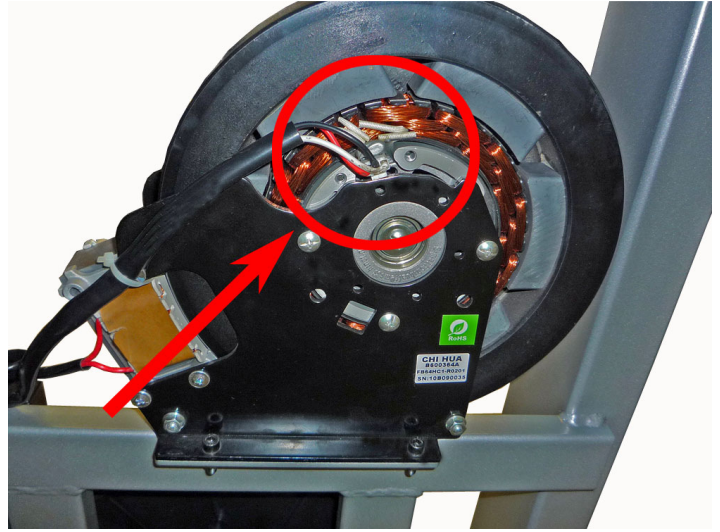
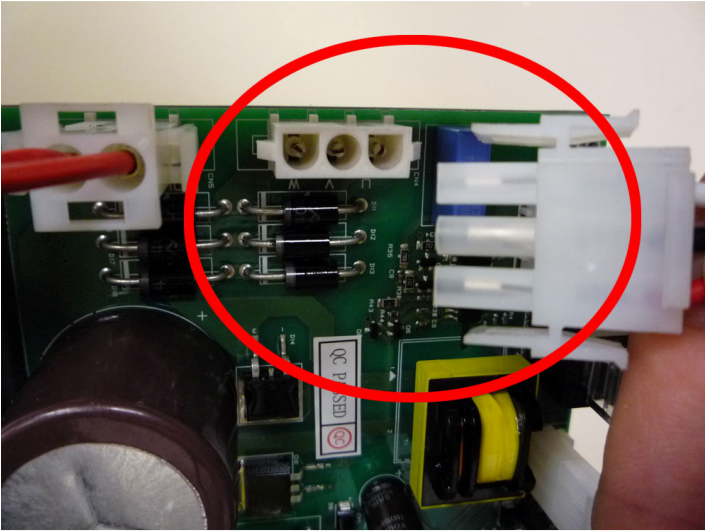

H. Brake Cable Connector (CN5 – 2 Pin Connector) – Controls the brake resistance.

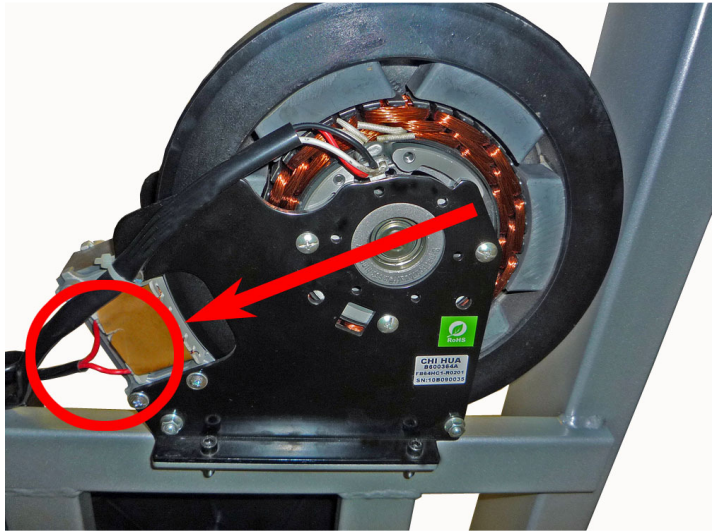
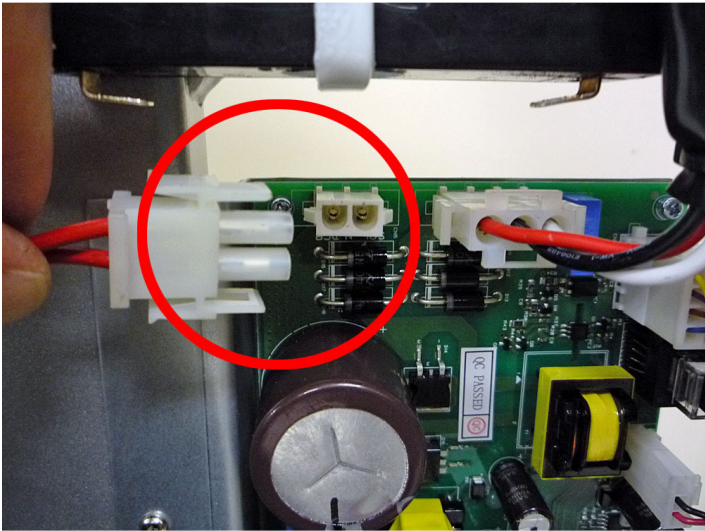

3. Mechanical/Drive Components:

- A. **Drive belt** – This belt connects the main pulley with the generator/brake to produce the needed voltage and create resistance when the user wants that.

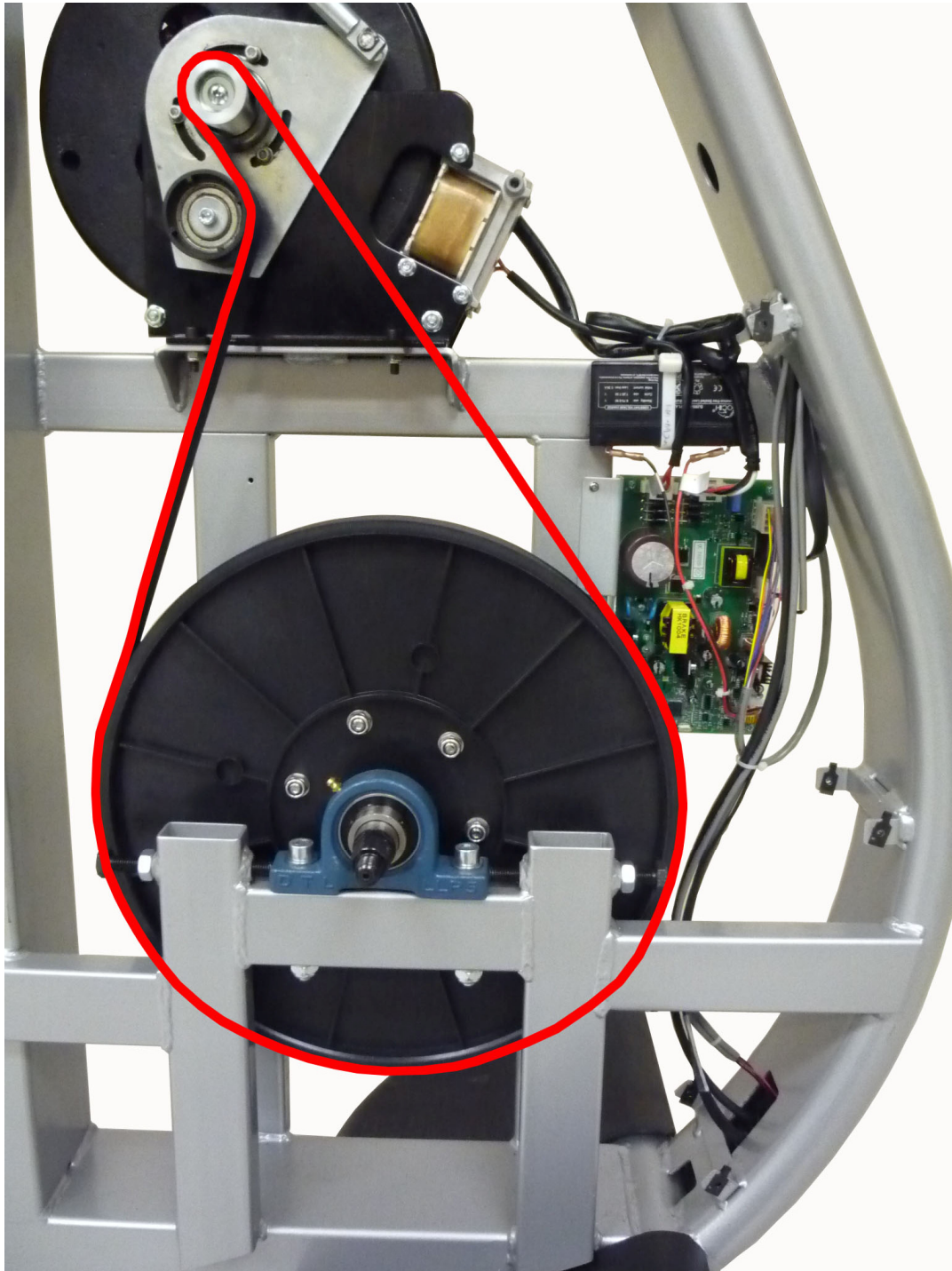

B. Belt Tensioning Lever – Assures that the tension of the drive belt is always at the right level.

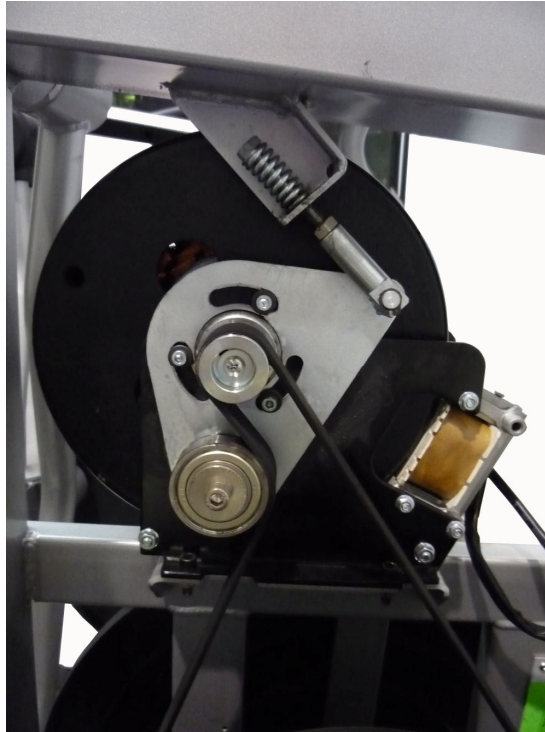

C. Drive Shaft Alignment Screws – These are used for proper drive shaft/drive belt alignment. They are located on both sides of the drive shaft.

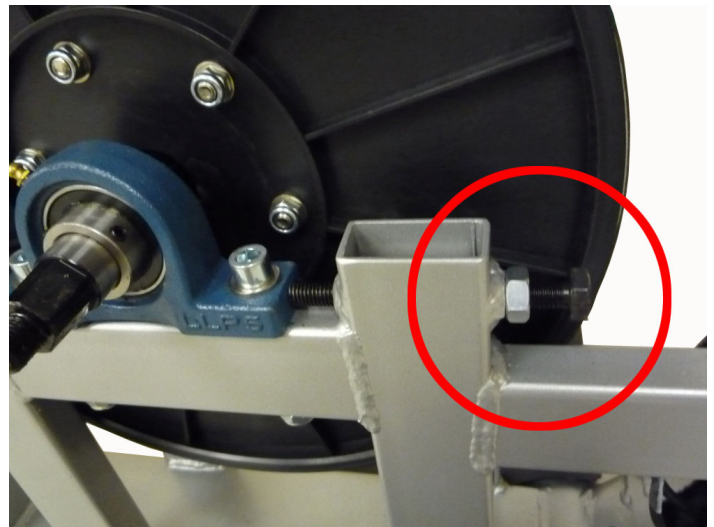
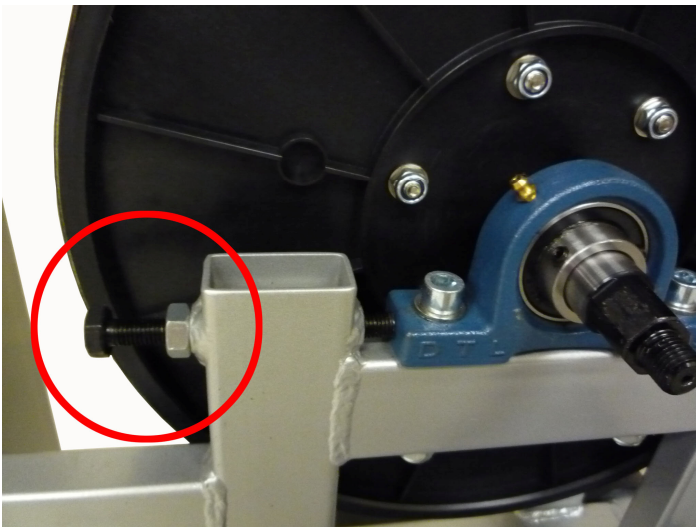

D. Leg Roller and Guide Rod – They are exposed to a lot of load. Front to rear motion only.

